

VANTAGE CARNAGE

BUGGY

**1/10 SCALE 4WD READY-TO-RUN BRUSHLESS
ELECTRIC MOTOR POWERED RACING TRUGGIES & BUGGIES**



INSTRUCTION MANUAL

www.ftx-rc.com





FTX Carnage, Vantage or Bugsta Brushless 2.4GHz Truggy/Buggy

Congratulations on your purchase of the FTX Vantage or Bugsta 4WD electric buggy or FTX Carnage 4WD Monster Truck. This 1/10th scale model has been factory assembled and all electrics installed and set up to make it the easiest possible introduction to the sport of driving RC cars.



Safety Precautions and Warnings

- You are responsible for operating this model such that it does not endanger yourself and others, or result in damage to the product or the property of others.
- This model is controlled by a radio which is possibly subject to interference which can cause momentary loss of control so it is advisable to always keep a safe distance to avoid collisions or injury.
- Age Recommendation: 14 years or over. This is not a toy. This product is not intended for use by children without direct adult supervision.

Carefully follow these directions and warnings, plus those of any additional equipment associated with the use of this model, chargers, ESC and motors, radio etc.

- Never operate your model with low transmitter batteries.
- Always operate your model in an open area away from cars, traffic or people.
- Never operate the model in the street or in populated areas.
- Always keep the vehicle in direct line of sight, you cannot control what you cannot see!
- Keep all chemicals, small parts and anything electrical out of the reach of children.
- Avoid water exposure, moisture causes damage to electronics and may result in the loss of control or permanent damage.
- Avoid injury from high speed rotating parts, gears and axles etc.
- Novices should seek advice from more experienced people to operate the model correctly and meet its performance potential.
- Exercise caution when using tools and sharp instruments.
- Do not put fingers or any objects inside rotating and moving parts.
- Take care when carrying out repairs or maintenance as some parts may be sharp.
- Do NOT touch equipment such as the motor, electronic speed control and battery, immediately after using your model because they can generate high temperatures.
- Always turn on your transmitter before you turn on the receiver in the car. Always turn off the receiver before turning your transmitter off.
- Keep the wheels of the model off the ground, and keep your hands away from the wheels when checking the operation of the radio equipment.

WARNING: Read the ENTIRE instruction manual to become familiar with the features of the product before operating. Failure to operate the product correctly can result in damage to the product, personal property and cause serious injury. This is NOT a toy and must be operated with caution and common sense. Failure to operate this product in a safe and responsible manner could result in damage, injury or damage to other property. This product is not intended for use by children without direct adult supervision. It is essential to read and follow all the instructions and warnings in the manual, prior to assembly, set-up or use, in order to operate correctly and avoid damage or serious injury.

Contents:

Vantage/Carnage/Bugsta 1/10th 4WD RTR Electric Vehicle.
Transmitter: 2.4GHz Steerwheel.
Charger: Input Mains 240V AC. Output 300mA DC
Battery: 7.2V 1800mAh NiMH
Aerial Tube



Required equipment for operation

1. Tools required for building and maintenance:

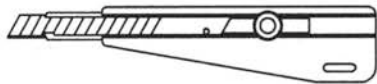

● Hobby knife

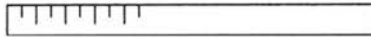

● Precision ruler

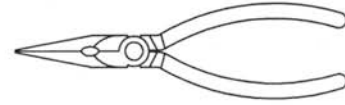

● Needle nose pliers

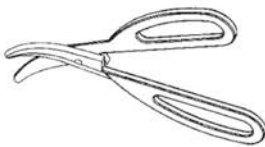

● Lexan scissors

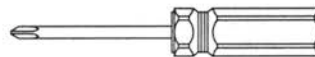
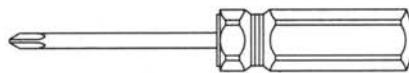

● Flat and Philips screwdriver

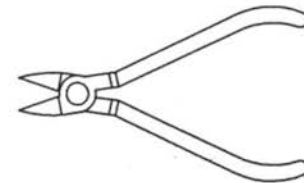

● Wire cutters

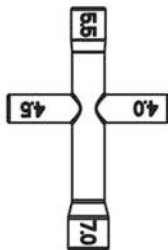

● Cross wrench

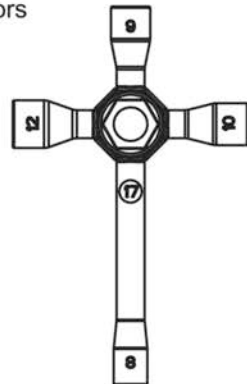

● Cross wrench



● CA glue&rubber cement



● Thread locking compound



● Hex wrench

WARNING!

Do not use a power screw driver to install screws into nylon or plastic materials. The fast locking may heat up the screws being installed that may break the molded parts or strip the threads during installation.

2. Additional items needed for operation:

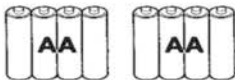

8 pcs AA Alkaline batteries for transmitter

IMPORTANT!

Check that all screws and nuts are tight before each use.



Aerial Assembly.

As the aerial wire on 2.4GHz systems is so short you do not need to protrude through the body shell and it can be left to stand directly from the receiver. If you want the security of an aerial tube anyway simply cut it short, and insert in the usual way but do NOT bend over the last 5mm of aerial wire to retain it under the rubber cap, the last two inches of aerial wire need to be straight with no kinks for maximum range and control with 2.4GHz systems.

First be sure to insert the wire up through the top chassis aerial mount hole from below. Pull the rubber tube cap off the aerial tube and push the wire all the way through the aerial tube until the first 5mm of wire shows out of the other end. Push Aerial tube into mounting hole in upper chassis until firmly seated.

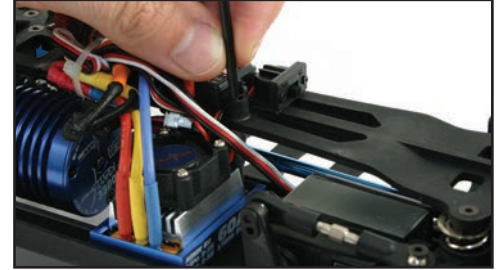
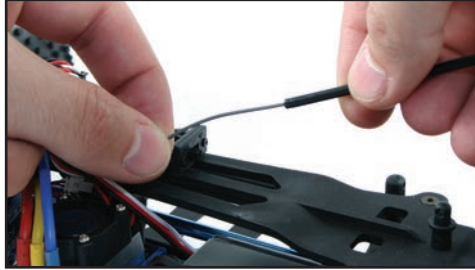
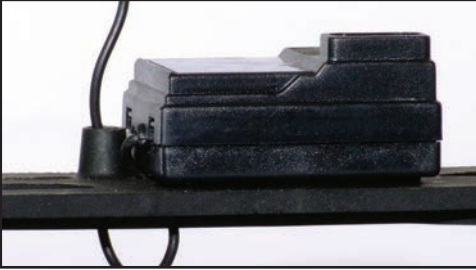

Charging/Installing the Battery.

Always store your model with the battery pack unplugged and removed. Always charge your battery away from the vehicle. The included 800mAh mains LiPo balance charger will take up to 3.5 hours to re-charge the LiPo battery depending on how discharged it is.

Before you start charging ensure that your LiPo battery is put inside the Voltz Vault safety LiPo sack.

(Lipo batteries can be dangerous and must be handled with care. Before commencing with charging ensure you familiarise yourself with our safety guidelines at the back of the manual. Failure to do so could result in injury or damage. Lipo batteries require completely different charging and care than NiCd and NiMH batteries and must be used with a LiPo specific charger.

Misuse can result in fire, personal injury and/or damage to property. The user assumes all liability and risk associated with the use of Lithium-Polymer (Li-Po) batteries. Immediately return the battery, unused, if you do not agree with these terms).



WARNING! NEVER LEAVE THE BATTERY UNATTENDED WHILE ON CHARGE.

The supplied charger can charge either 2s or 3s (cell number) LiPo batteries. The supplied battery is a 2s ensure you plug it into the correct 2s balance port.

When the charger is connected to the mains power the power LED will turn green. Once you connect your balance connector to the charger the status LED will turn Red indicating that charging is in progress. Once the battery is fully charged the status LED will turn green. If you experience the LED blinking red then there is an error with either the battery or charger.



When charging a completely discharged battery, the charger can become hot to touch. NEVER LEAVE THE BATTERY CHARGING UNATTENDED. Always disconnect the charger from the mains supply and the battery pack when not in use.

To install a charged battery into the vehicle, remove the body clips and remove the bodyshell. Remove the battery retainer clips, insert battery and reinstall retainer with the flat side facing the battery and re-insert clips.



Notes on Battery use:

Always allow the battery cool after use, before recharging.

Always inspect the battery before charging.

Any bare wires, split heat shrink or leakage is a sure sign of abuse.

Never attempt to charge dead or damaged batteries.

Do not disassemble the battery or cut the connector wires.

If the battery connector, battery case or cable insulation get hot enough to melt or split there is most likely a serious problem with your model, driveline, battery wires or speed controller. Find and correct the problem before installing another charged battery pack.

(please refer to our detailed LiPo handling page at the back of the instructions)

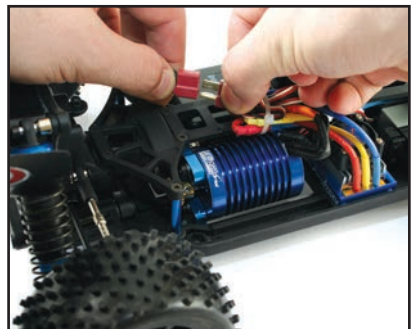



Etronix Photon 2.1W Sensorless Brushless Speed Controller

The Photon 2.1W is specifically designed for operating Sensorless brushless motors. We strongly recommend you to read these instructions thoroughly before using the ESC.. Etronix has no control over the use, installation, application or maintenance of these products, thus no liability shall be assumed nor accepted for any damages, losses of costs resulting from the use of this item. Any claims arising from the operating, failure or malfunction etc. will be denied. We assume no liability for personal injury, property damage or consequential damages resulting from our product or our workmanship. As far as is legally permitted, the obligation for compensation is limited to the invoice amount of product in question.

Features:

- Enhanced throttle response, excellent acceleration, strong brakes and throttle linearity
- Using both of LCD and LED program card to make adjustments (optional with some packages).
- Multiple protection features: Low voltage cut-off protection, over-heat protection and throttle signal loss protection

Begin to Use The New ESC:

Please attend to each connections and make sure each assignment is correct.

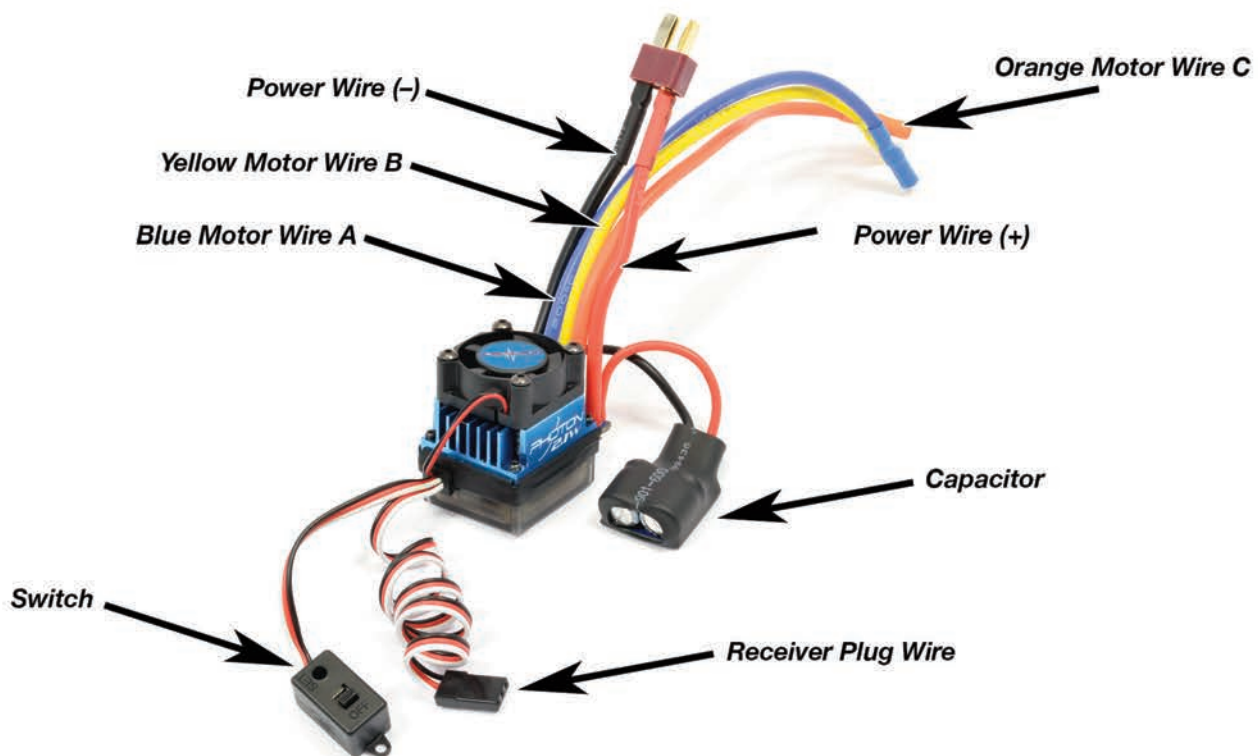

* Sensorless Mode

When using a Sensorless Brushless motor, the Blue motor wire A , Yellow motor wire B and Orange motor wire C of the ESC can be connected with the motor wires randomly. If the motor runs in the opposite direction, please swap any two wire connection.

* Connection to the Receiver

Black wire RX-
 Red wire RX+6.0V
 White wire RX-Signal



LEDs:

Throttle Range Calibration

1. Turn on the transmitter, then connect ESC with the battery packs and set the direction of the throttle channel to REV; set the EPA/ATV value of the throttle channel to 100%.
2. Press and hold the "Set" button and switch on the ESC, release the button when the orange LED turn solid. Pull the throttle trigger to full position, red Led light will flashes, Led will turn solid and motor beeps once. when system confirms the position.
3. Push the throttle trigger to full Brake position, red Led light will flashes, Led will turn solid and motor beeps twice when system confirms the position.
4. Now trigger goes back to neutral position, both of the Red Led and Orange Led blink, Led lights will turn solid and motor beeps three times when system confirms the position.
5. Turn off the ESC power switch to save the settings.
6. Turn the ESC back on. You are ready to use the ESC now.

Additional ESC Settings when using OPTIONAL programming card.

Programmable items and default settings

Default settings are shown in the grey boxes

Optional LED programming card



| programmable Items | Programmable Value | | | | | | | | | |
|--------------------------|---------------------|---------------------------------|-----------------|-----------|-----------|------------|-----|-----|------|--|
| | 1 | 2 | 3 | 4 | 5 | 6 | 7 | 8 | 9 | |
| Cut-off Voltage | 2.6V/cell | 2.8V/cell | 3.0V/cell | 3.2V/cell | 3.4V/cell | No cut-off | | | | |
| Running Mode | Forward w/o Reverse | Forward with pause then Reverse | Forward/Reverse | | | | | | | |
| Motor timing | Very Low | Low | Normal | High | Very High | | | | | |
| Initial Acceleration | Low | Medium | High | Very High | | | | | | |
| Throttle Percent Reverse | 20% | 30% | 40% | 50% | 60% | 70% | 80% | 90% | 100% | |
| Throttle Limit | 0% | 20% | 30% | 40% | 50% | 60% | 70% | 80% | 90% | |
| Percentage Braking | 10% | 20% | 30% | 40% | 50% | 60% | 70% | 80% | 100% | |
| Percentage Drag Brake | 0% | 4% | 8% | 12% | 15% | 20% | 25% | 30% | | |
| Motor Rotation | Normal | Reverse | | | | | | | | |
| Neutral Range | 2% | 3% | 4% | 5% | 6% | 10% | | | | |



1. Cutoff Voltage

- **Automatically detect the number of the cells**

According to the type of your batteries, set up the type of the batteries and Low Voltage Cutoff Threshold via program card. The ESC can detect the Voltage of the battery anytime and will **lower the power output** once the Voltage of the battery is lower than the preset Low Voltage Cutoff Threshold.

- When using **NiMH or NiCd batteries** you do not need to set a cutoff voltage to protect the batteries. When the voltage of the battery packs is within 8.4~11.1V the ESC will automatically identify 3S LiPos. When the voltage of the battery packs is less than 8.4V the ESC will automatically identify 2S Lipos.
- When using any **Lithium batteries**, they must not be discharged to less than 3.0V per cell.

2. Running Mode

- **Forward w/o Reverse**

This is a Race setting - Reverse is disabled.

You will find in racing, most tracks will not allow racing with reverse enabled.

- **Forward with pause then Reverse: (DEFAULT)**

General bashing around (FUN) or racing if reverse is allowed for the event. The Electronic Speed Controller requires 2 seconds of continuous neutral from the transmitter prior to allowing reverse to operate.

Note: There is automatic protection within the Photon 2.1W ESC. Only after you have stopped and returned the trigger to neutral will reverse become available. You cannot instantly switch reverse into forwards. This is to help prevent serious damage to the drive train.

- **Forward / Reverse**

If the option is activated, the RC car could go forward and backward, but could not brake.

ESC – reverse operation

Should you get into a situation that requires reverse, after you have applied any brakes you may have needed, return the throttle trigger to the neutral position. Wait a moment or two and then push the trigger forward for reverse.

3. Motor Timing - This option affects the power band and efficiency (run time) of an electric motor. The default is "Normal" and is a good starting point to deliver power and provide good run time.

- **Very Low** Provides maximum efficiency with less power. Higher timing produces significantly more power but at the expense of efficiency (less run time) and typically the motor will generate more heat. Each brushless motor will respond to timing differently. Good for running around on paved, or harder surfaces, and racing with high KV rated or low-turn motors
- **Low** Provides power for running through soft surfaces, having fun and longer run time.
- **Normal (Default)** Good mix of power and efficiency using any motor
- **High** More power than efficiency so run time will reduce, and you should be monitoring motor heat. The higher KV or lower turn motors will generate heat quickly using this setting. A safe high temperature range is 165F to 180F (74° - 82° Celsius), going higher may damage your motor.
- **Very high** This is maximum power and must be used with **caution**.

Note : Any motor has the potential to over-heat in this setting. Frequently check the motor temperature and make sure you're not operating higher than 165° and 180° Fahrenheit (74° - 82° Celsius), which may damage your motor, or damage your Electronic Speed Controller (ESC).

4. Initial Acceleration - Use this to limit the initial power that is sent to the motor when starting from a complete stop.



Using the low option, the vehicle will launch very slowly and provide the longest run times. When using the HIGH choice, you will have wheel-spinning acceleration at the cost of run time. This is also very tough on the batteries as the amperage draw can be very high. If your vehicle cuts out, hesitates or loses radio control, you should consider setting this at a lower value.

- **Low** Using this option will provide longer run times and is easiest on the batteries. It is a good choice for beginners.
- **Medium** Medium requires more from your batteries, and is good for low traction surfaces.
- **High** This option will provide full acceleration and requires stout batteries to supply the load required in this setting.
- **Very high** This option will provide full acceleration and requires stout batteries to supply the load required in this setting.

5. Throttle Percent Reverse - Use this to limit the power available using reverse throttle. The lower the percent or level the less speed will be available in reverse.

20%, 30%, 40%, 50%, 60% (Default), 70%, 80%, 90%, 100%

6. Throttle Limit - Use this to limit the power available using forward throttle.

The lower the percent the less forward throttle speed will be available.

0% (Default), 20%, 30%, 40%, 50%, 60%, 70%, 80%, 90%

7. Percentage Braking - Gives you the ability to have full control over the amount of brake your vehicle will have.

10%, 20%, 30%, 40%, 50% (Default), 60%, 70%, 80%, 100%

8. Percentage Drag Brake - 0% (Default) 4%, 8%, 12%, 15%, 20%, 25%, 30%

The drag brake function provides the driver a set percentage of brake when you have the transmitter resting in neutral. This will create the "feel" of a brushed motor.

Drag brake are used in racing to slow a vehicle as you let off approaching a corner versus the driver having to push the brake at every corner.

Try working with this to get a sense of how you might use this for your track.

If you are running on a high traction track with tight corners, a stronger setting should work best.

If you are running in an open area, you will find a smaller percentage will result in better control.

If you are running in dusty or slippery surfaces, you will more than likely want to use the lowest option.

9. Motor Rotation

Normal (default), Reverse

10. Neutral Range - This setting adjusts the amount of "Deadband" off neutral on the throttle trigger. This is in Milli-Seconds (MS) and is the amount of neutral when you pull the trigger.

The smaller the value the less "Deadband" or movement is required off-center for the ESC to begin throttle functions.

Using a higher value for this setting will provide a wider Deadband.

- 2% 3% 4% (Default) 5% 6% 10%

Using LED Program card

1. The Etronix Program card with LED display is easy to use and convenient to carry. All of the programmable functions are shown on the program card.
2. Turn on the ESC. Remove the Signal wire and plug it into the top-socket on the Program card, wait for 2 seconds until the LED is ON. The first programmable function will be shown, if an error occurs, please reconnect them.
3. If ESC is not connected with the batteries, the Program card should be connected with other power supply, the range of power supply is within 5.0-6.3V.
4. Press the button "Menu" on the Program card and circularly select each programmable function. At that time the number of the programmable function will be displayed on the left of the LED, the current value will be displayed on the right side. Then press the button Value to change the value and press the button OK to confirm. At the same time the Red indicating LEDs of both program card and the ESC blink. Turn off the ESC, the modified settings will be saved in the ESC's memory.
5. Press the button Reset to restore the default settings.



2.4GHZ RADIO SET-UP

Etronix Pulse EX2 Sport

2 Channel 2.4GHz Steer Wheel Transmitter

1) INTRODUCTION.

Thank you for choosing this Etronix 2.4GHz radio system, it has been designed for land use but could also suit any 2 channel boat. If you are using this type of product for the very first time, please make sure you read all the information provided before installing in your vehicle. Please take special care of any warning notices to ensure safe operation.

2) SERVICE.

If you experience any difficulties please refer back to the manual, and if problems persist contact your retailer or distributor for further assistance.

3) SAFETY.

If you do not read, fully understand, then follow the advice and instructions in this manual properly, you risk damaging your radio or your model irreparably, even injury, or causing harm to another person or their property.

4) USER GUIDES.

Do Not drive at night, in bad weather, thunder and lightning, during rain, or on wet roads.

Do Not drive in the street between parked cars, near people or children, or dog walkers.

Always check the proper operation of your model. If it does not respond properly or reacts unpredictably please check the installation and condition of your equipment.

Ensure the throttle trigger is at the neutral position before powering up, to avoid your model running away before you get proper control.

Never turn off the transmitter before the receiver, although fitted with a failsafe device, it is good practice to keep the model under control at all times.

Remember :- Transmitter on first. Receiver off first!

5) BATTERY CARE.

If your transmitter or receiver is being powered by rechargeable Nickel Cadmium or Nickel Hydride batteries, be sure to always check they are fully charged and in good condition before use. Loss of control could soon result if partially charged, discharged or damaged batteries are installed. When charging NiCd or NiMH batteries always use a dedicated charger, never try to recharge dry cells. If at any time during use or charging your transmitter or receiver batteries show signs of severely over heating, swelling or leaking, disconnect immediately, dispose of properly and replace!



6) TRANSMITTER CHARGING.

Connect a dedicated transmitter charger to the power supply.

Connect the charger to the charging socket on the rear of the handset.

When charging is complete, disconnect.

If using dry (alkaline) cells do not attempt to connect a charger to the transmitter!



Install eight 1.5V (AA size) rechargeable batteries in the transmitter base and re-fit the bottom cover.

7) TRANSMITTER SPECIFICATION.

| | |
|----------------------|--|
| Channels : | 2 |
| Frequency: | 2.4GHz |
| RF Power : | <20 dbm |
| Modulation: | GFSK |
| Code Type: | Digital |
| Sensitivity: | 1024 |
| Power: | 12V DC (8 x 1.5V AA) |
| Low Voltage Warning: | <9V DC |
| Charger Port: | 5mm Centre Positive (Charger Not Included) |
| DSC Port: | 3.5mm (for Optional USB Game Interface – NOT USED/SUPPORTED) |
| Antenna Length: | 120mm |
| Weight: | 328g |
| Size: | 159 x 99 x 315mm |
| Colour: | Black |
| Certification: | CE, FCC. |



8) KEY TO TRANSMITTER FEATURES.

- A - Folding/Rotating 2.4GHz Aerial
- B - Steering Wheel
- C - Throttle Trigger
- D - Control Panel Cover
- E - Battery Box
- F - DSC (Simulator) Port (NOT USED/SUPPORTED)
- G - Charger Port
- H - Steering Reverse Switch
- I - Throttle Reverse Switch
- J - Power (RED) LED
- K - Bind/Battery Condition (Green) LED
- L - 'Bind' Button
- M - Steering Trim Dial
- N - Throttle Trim Dial
- O - Steering Dual Rate Dial (D/R)
- P - Power On/Off Switch

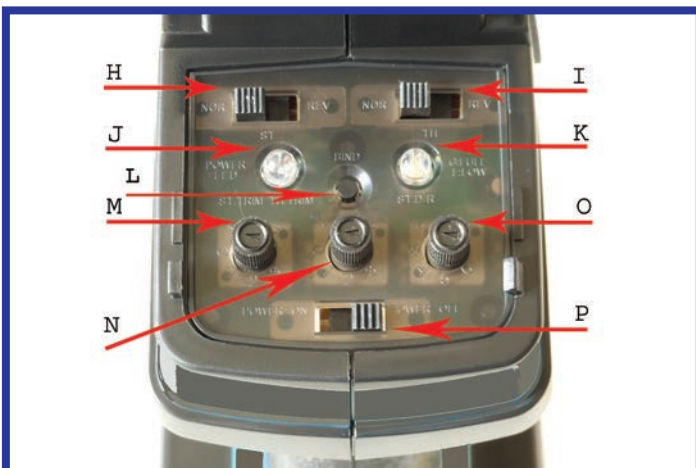

9) TRANSMITTER FUNCTIONS.

A vertical aerial achieves maximum range, so the short 2.4GHz aerial (A) can be folded and rotated to achieve the most vertical position once you are holding the handset comfortably. Then it allows you to fold the aerial away for safe storage.



The aerial folds down for storage
The aerial base also rotates 180 degrees so once you have a comfortable grip on the transmitter the aerial can be moved to the most vertical position to maximise range.

The Steering Wheel (B) operates Channel 1 and when turned anti clockwise the model should steer to the left and vice versa. If not, simply flick the Steering Reverse Switch (H) to the "Rev" position. The Throttle Trigger (C) operates Channel 2 and when pulled towards the handset the model should move forwards, when pushed away it





When at the mid position the model should remain stationary, if it creeps slightly adjust the throttle neutral dial accordingly.



When pulled back to the handset the model should move forwards, if not flick the Throttle switch to the 'Rev' position.



When pushed away the model should brake (and then move in reverse if applicable) if not simply flick the throttle switch to the 'Rev' position.

should brake (and then reverse if available), otherwise simply flick the Throttle Reverse switch (I) to the "Rev" position.

Beneath the folding Control Panel Cover (D) you will find an array of useful adjustments, plus the Power Switch (P).

When the Power Switch (P) is moved left to the 'On' position, the RED LED (J) lights up, as does the Green LED (K), this shows a good battery condition.



If the transmitter batteries are weak and the voltage drops below 9V DC, the green LED flashes to alert you to the possibility that range will be limited and control might be lost, so new batteries (or a recharge) are advisable.

If the model does not track straight, adjust the Steering Trim Dial (M).
If the model creeps forwards or doesn't sit at Neutral, adjust the Throttle Trim Dial (N).

The Steering Dual Rate Dial (O) controls the total amount of steering available. If the servo is straining against the steering end stops, turn it down (clockwise) until it only just achieves maximum steering lock. If the vehicle exhibits excess steering, or when at high speed you feel it over reacts to the slightest adjustments, turn the Steering Dual Rate Dial down yet further until the model becomes more controllable, but not so

far that you struggle to negotiate the tightest corner on the course. If the servo is connected to the receiver correctly but the model does not steer at all, double check the Steering Dual Rate Dial is not at Zero, before checking for any more serious faults!

10) RECEIVER SPECIFICATION.

Channels: 3

Failsafe: Throttle Set Point Adjustable.

Frequency: 2.4GHz

Modulation: GFSK

Sensitivity: 1024

RF receiver sensitivity: -100dbm

Power: 4.5 to 6V DC

Weight: 5g

Antenna Length: 176mm

Size: 37.6 x 22.3 x 13mm

Colour: Black

Certification: CE, FCC.

11) RECEIVER INSTALLATION.

The receiver should be securely mounted flat and level in your model, within the receiver box if available to protect it from moisture and dust. When routing the aerial keep it as far

away from any electronic devices and metal work as reasonably possible, with at least the last half of the aerial wire in a vertical aerial tube to maximise control and range.

For Nitro or Petrol powered models connect the receiver battery (noting correct polarity) into the socket marked "VCC" or via a suitable power switch.

Electric vehicles equipped with an ESC should power the radio (via the BEC) when plugged into channel 2, and receiver power is usually controlled by the ESC switch.

The third channel is not used on this transmitter, so the third (bind) socket can be used to power a cooling fan or Personal Transponder (PT).



12) MATCHING THE RECEIVER TO THE TRANSMITTER. (BINDING)

To make sure only one transmitter can control the receiver they need to be matched, and to do so you need to "Bind" them together so they only recognise each others signature code. There is a 'Bind' plug included with the receiver, and this is inserted in the third channel (Bind socket) before power is supplied to the receiver for the first time. The red LED on the receiver will begin to blink to indicate the bind process has begun. Now hold down the transmitter bind button (L) before it is switched on. The transmitter's green LED (K) begins to blink and the receivers red LED stops flashing and turns solid red to indicate the bind process has been achieved. Before you can operate the model, both the receiver and transmitter should be switched off and the bind plug removed from the receiver for safe keeping. Now switch on the transmitter before the receiver and the model should respond normally. If the receivers red LED does not go solid when it is powered up and the transmitter is on, then 'Binding' has failed, so begin the matching process again.

Remember if this is the first time you have set up the radio in your model, the steering and throttle will need correctly adjusted neutral positions before you will have proper control, and the throttle failsafe position should also be set before your first run.

13) RECEIVER FAILSAFE OPERATION.

This Etronix receiver incorporates a digital protection system known as a failsafe. If the model goes beyond the usable range, or the signal is interrupted, the failsafe will automatically set the



Hold down the transmitter "Bind" button before switching the power on.



With the power on you can release the bind button once the green LED begins to flash to indicate the "Bind" process has initiated.

throttle (channel 2) to a preset position so long as power is still supplied to it. Set up the failsafe before first use, by turning on the transmitter, then supplying power to the receiver. A pointer is supplied (on the bind Plug) which can be used to hold down the failsafe button on the receiver for three seconds until the red LED flashes several times to indicate successful setting of the failsafe position. Now, wherever the throttle channel was positioned, will be the throttle servo failsafe set point.

To test the failsafe, hold the model clear of the ground and apply a little throttle before turning the transmitter off. Within a second, the throttle servo (or speed controller) should have repositioned to the failsafe position, which is typically throttle neutral position so the vehicle just rolls safely to a halt if the signal is lost. Note:- if the receiver is re-matched to the transmitter for any reason (See 'Binding' as above) the failsafe position is lost so it will need to be reset again.

Thank you for choosing Etronix, used properly and observing the information in this manual we believe the Pulse EX2 Sport will achieve a strong connection with your model, utilising all the benefits of crystal free 2.4GHz technology for exceptional control and interference free operation.



Unless a battery powered model using an ESC with BEC, a receiver pack should be plugged into the VCC socket via a suitable power switch, making sure to check for correct polarity.



To 'Bind' the receiver to the transmitter the supplied Bind Plug should be installed channel 3/bind socket before power is applied. The red LED should begin to flash to indicate the 'Bind' process has begun, and go solid red once 'Bind' is complete. Now remove the 'Bind' plug and restart the power up procedure.

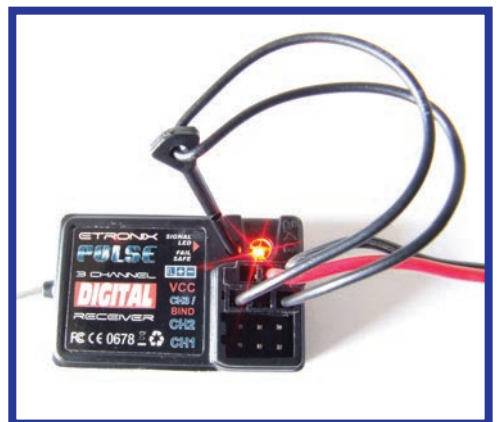

Once the 'Bind' process is complete, the throttle failsafe position can be set by pressing the button using the pointer provided.



Getting Started

Refer to 2.4ghz binding manual for radio set-up.

Switch on transmitter.

Hold vehicle clear of the ground, connect battery pack and switch on receiver.

Test the transmitter to check control of the vehicle with wheels off the ground.

Start driving slowly and if the vehicle does not go straight, adjust steering trim dial on Transmitter.

For the very first run use the throttle gently, to help the driver become accustomed to the vehicles behaviour and controls.

Although this vehicle features waterproof electronics they are not designed to be submerged in water. Potential damage can still occur to vehicles components if you do so.

After Run.

Switch off the receiver power, switch off the transmitter. Disconnect the battery and remove it from the vehicle, allow it to cool before recharging. If you have a second charged battery all ready to use, still allow the vehicle to cool slightly before continuing.

Regular maintenance.

Frequently check the whole vehicle for loose or missing fixings. Use thread lock on any replacement screws into metal threads.

Frequently check rotating parts are free from grass, string etc. that might bind their motion and over stress the motor or speed controller. Remove the wheels occasionally and check behind the mounting hex for obstructions or anything that might have been wrapped around the axle and caused extra drag.

Check the gear mesh frequently and remove any stones or grit from gear teeth to prevent premature wear and damage.

If the motor moves, or is removed for maintenance/exchange, the gear mesh will need to be set. Simply slacken the motor retaining screws and adjust the motor until there is just discernable backlash between pinion and spur teeth. If the gear is too tight or too loose the gears will be noisy and could be damaged.

Shock absorbers will wear prematurely if used in dirty dusty conditions. Replace oil and seals as required to keep a smooth dampening action.

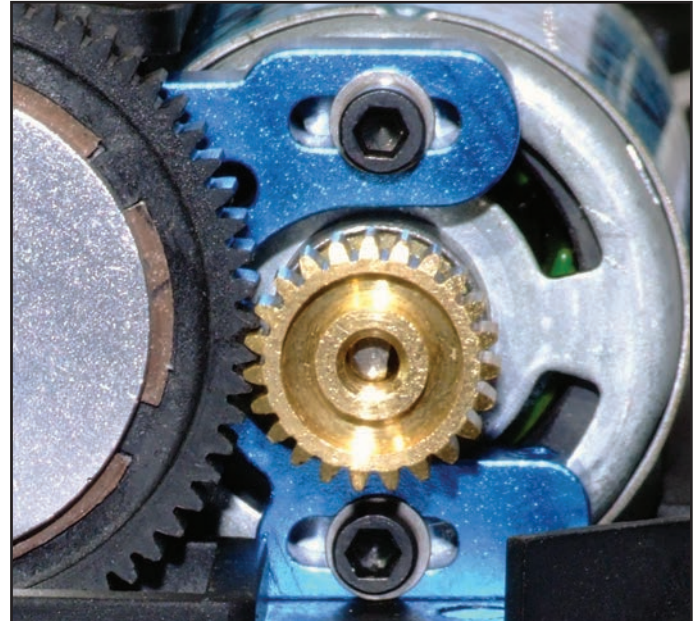

Trouble shooting guide.

| | | | | |
|---|--|--|---|--|
| Short Runtime: Battery damaged/not charged Motor dirty or brushes worn Drivetrain binding | Sluggish Action: Motor damaged. Bind in drive train Battery running low on power | Motor/ESC overheat: Over-gearred Binding transmission. Seized axle bearing. Motor binding | Motor spins but vehicle refuses to move: Gears damaged. Gears loose on shaft. Magnets debonded from motor armature Slipper clutch too loose. Drive shaft broken or missing. | Poor Range or fails to operate: Transmitter batteries low Vehicle Battery Low. Transmitter switched off Transmitter/receiver aerial not extended. ESC switched off or battery not connected. Loose connectors/wires. 2.4ghz binding with receiver lost |
|---|--|--|---|--|



LIPO BATTERY - USER SAFETY AND HANDLING INSTRUCTIONS.

Read all safety instructions before charging or using your batteries for the first time.

Lipo batteries require completely different charging and care than NiCd and NiMH batteries. Misuse can result in fire, personal injury and/or damage to property. The buyer assumes all liability and risk associated with the use of Lithium-Polymer (Li-Po) batteries. Immediately return the battery, unused, if you do not agree with these terms.

General guidelines and warnings:

1. Use a Lithium Polymer specific chargers only! Do not use a NiCd or NiMH charger.
2. NEVER charge unattended. Always charge in safety sack or metal tin with lid and away from other flammable materials.
3. During the charge process watch for swollen or ballooning cells. If this happens immediately disconnect the charger and move the battery to a fire proof place for 15 minutes. Do not attempt to charge again.
4. A short circuit can cause a rapid discharge of high currents. Avoid short circuits, and be aware of short circuits on jewellery.
5. Any Lithium Polymer battery involved in a crash should be removed and observed in a fireproof space for 15 minutes before continuing to use or charge the battery.
6. If rewiring the battery pack, rewire the leads one at a time. Do not cut both leads. Do not short circuit on tools.
7. Do not expose battery packs to direct sunlight for extended periods.
8. Do not attempt to tamper with or open the LiPo Hardcase. The case is protection against possible battery swelling.

Before charging:

Visually inspect the pack checking for damaged leads, connectors, cracked heat shrink covering, swelling or other abnormalities. Do not charge if the pack is damaged.

Charging process:

1. NEVER charge unattended.
2. Charge away from flammable materials and inside a Lipo safe sack or metal tin with lid.
3. Allow battery to cool before charging.
4. Use the battery label for setting charger cell count and voltage.
5. Do not exceed 5C MAX charge rate. (Example, charge a 1000mAH pack at 5A MAX)

If disposing of a LiPo battery proceed as follows:

Submerge the battery into a container filled with about 10 litres of salt water (one cup of salt in 10L). Leave the battery submerged for 2 weeks, this will slowly and safely discharge the battery until the voltage has dropped to zero volts which eliminates the risk of any chemical reaction. It can then be disposed off in the general waste collection.

Warranty

Due to the nature of this product and potential use FTX warrants it to be free of material and workmanship defects when new. FTX will at its sole discretion repair or replace defective components free of charge within 30 days from date of purchase. This warranty does not cover wear and tear, crash or impact damage, modifications, water damage from being completely submerged, failure to perform maintenance or damage from improper use.

Proof of purchase date will be required to action any warranty claims.

Instructions for disposal

Environmental Protection Notes & WEEE

The crossed-out wheeled bin symbol shown here, which may be found on the product itself, in the operating instructions or on the packaging, is in accordance with the Waste Electrical and Electronic Equipment (WEEE) Directive. Individual markings indicate which materials can be recycled and re-used. You can make an important contribution to the protection of our common environment by re-using the product, recycling the basic materials or recycling redundant equipment in other ways.

When this product comes to the end of its useful life, you must not dispose of it in the ordinary domestic waste. Many electrical items that we throw away can be repaired or recycled. Recycling items helps to save natural resources and also reduces the environmental and health impacts that are linked with sending electrical goods to landfill. The correct method of disposal is to take it to your local collection point for recycling electrical and electronic equipment. You can go to recycle-more.co.uk for details of locations.

Alternatively FTX can offer our customers free take-back of their WEEE on a like-for-like basis when they buy a new Electrical or Electronic product from us. For example, if a customer bought a new radio system from us or a dealer, we would accept their old radio and prevent it going into a landfill site by disposing of it safely. Customers must return their old WEEE item to us within 28 days of purchasing their new item.

Remove batteries from your device and dispose of them at your local collection point for batteries. If you don't know the location of your nearest disposal centre, please enquire at your local council office.



CML DISTRIBUTION, SAXON HOUSE, SAXON BUSINESS PARK,
HANBURY ROAD, BROMSGROVE, B60 4AD.

WEE/GB4215VX





Notes:

Dotted lines for writing notes.





VANTAGE CARNAGE BUGS

www.ftx-rc.com



**FTX IS AN EXCLUSIVE BRAND OF CML DISTRIBUTION, SAXON HOUSE, SAXON BUSINESS PARK,
HANBURY ROAD, BROMSGROVE, WORCESTERSHIRE, B60 4AD ENGLAND.
E-MAIL: INFO@FTX-RC.COM**

